

LFP12100(12V100Ah)

Specifications

Nominal Voltage		12 V
Capacity (25°C)	10HR(10.8V)	100 Ah
	5HR(10.5V)	87Ah
	1HR(9.60V)	62Ah
Dimension	Length	330 ± 2mm (12.99inch)
	Width	171 ± 2mm (6.73inch)
	Height	214 ± 2mm (8.43inch)
	Total Height	T5: 224 ± 2mm (8.82inch) T9: 220 ± 2mm (8.66inch)
Approx. Weight		30.kg (66.0lbs) ± 4%
Terminal type		T5/T9/T11
Internal resistance (Fully charged, 25°C)		Approx. 4.5m Ω
Capacity affected by temperature (10HR)	40°C	102%
	25°C	100%
	0°C	85%
	-15°C	65%
Self-discharge (25°C)	3 month	Remaining Capacity: 91%
	6 month	Remaining Capacity: 82%
	12 month	Remaining Capacity: 65%
Nominal operating temperature		25°C ± 3°C (77°F ± 5°F)
Operating temperature range	Discharge	-15°C ~ 50°C (5°F ~ 122°F)
	Charge	-10°C ~ 50°C (14°F ~ 122°F)
	Storage	-20°C ~ 50°C (-4°F ~ 122°F)
Float charging voltage(25°C)		13.50 to 13.80V Temperature compensation: -18mV/°C
Cyclic charging voltage(25°C)		14.50 to 14.90V Temperature compensation: -30mV/°C
Maximum charging current		30A
Terminal material		Copper
Maximum discharge current		800A(5 sec.)
Designed floating life(20°C)		12 years

- ◆ Absorbent glass mat technology;
- ◆ Recognized by UL & CE;
- ◆ ABS container.

Constant Current Discharge Characteristics (A, 25°C)

F.V/TIME	10min	15min	30min	60min	2h	3h	4h	5h	8h	10h	20h
9.60V	210	165	100	62.0	36.5	25.5	20.9	17.9	12.2	10.2	5.34
9.90V	204	161	98.0	61.1	36.3	25.4	20.8	17.7	12.2	10.2	5.33
10.2V	195	155	95.0	59.5	36.0	25.2	20.6	17.6	12.1	10.1	5.32
10.5V	187	150	92.7	58.3	35.5	25.0	20.5	17.5	12.0	10.1	5.29
10.8V	176	142	89.3	56.5	34.6	24.3	19.9	17.0	11.6	10.0	5.25

Constant Power Discharge Characteristics (Watt, 25°C)

F.V/TIME	10min	15min	30min	60min	2h	3h	4h	5h	8h	10h	20h
9.60V	2268	1812	1122	707	423	300	246	211	145	122	64.1
9.90V	2200	1768	1100	696	421	298	244	210	145	121	64.0
10.2V	2109	1703	1066	679	417	296	243	208	144	121	63.8
10.5V	2019	1645	1040	665	411	294	241	207	143	120	63.4
10.8V	1905	1558	1002	645	400	285	234	201	138	119	63.0

Note: The above characteristics data can be obtained within three charge/discharge cycles.



Dimensions

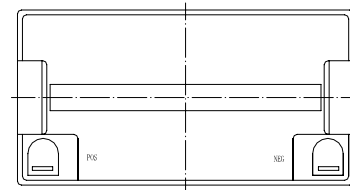
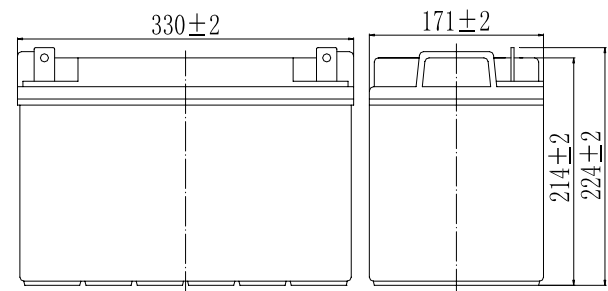

Terminal

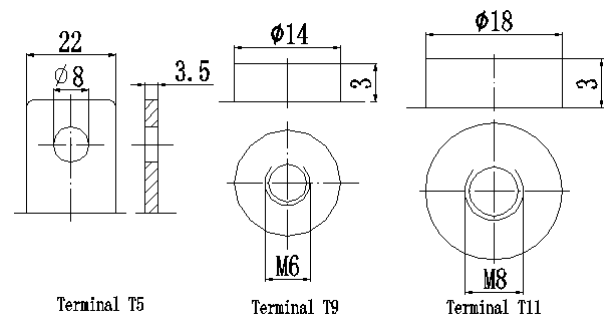

Terminal T11

Terminal T9

Terminal T5

LFP12100(12V100Ah)

Discharge Characteristics(25°C)

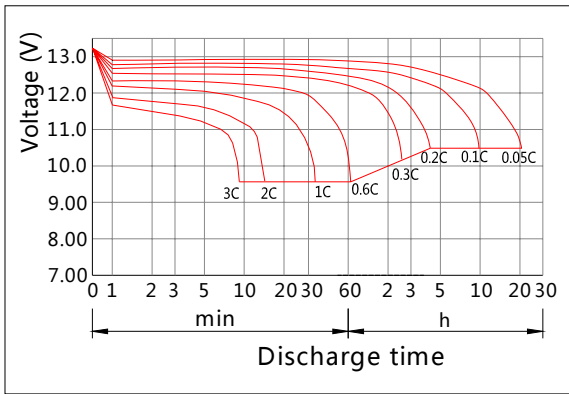

Charging Characteristics(25°C)

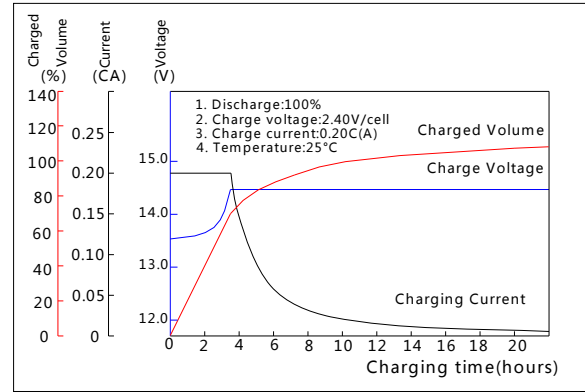

Effect of Temperature on Capacity

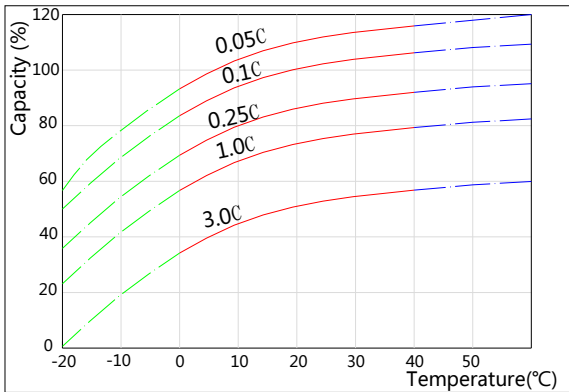

Self-discharge Characteristics

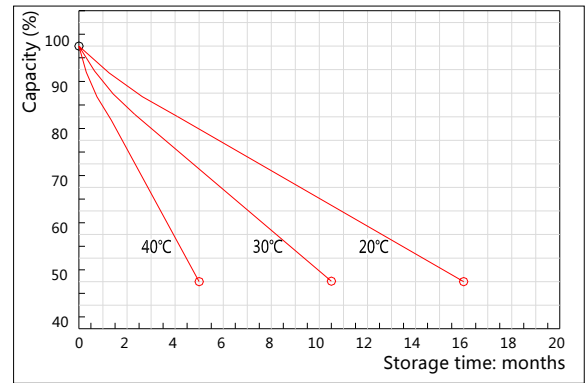

The Relationship for Open Circuit Voltage and Residual Capacity (25°C)

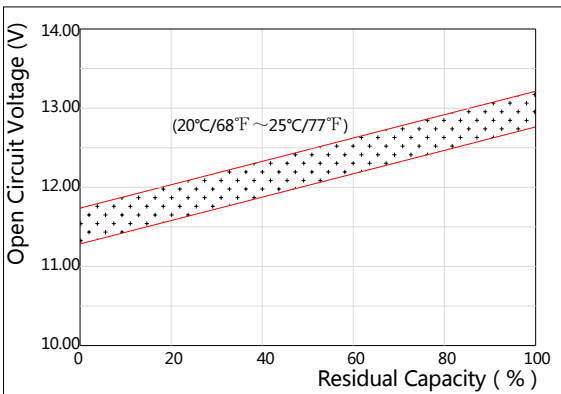

The Relationship for Charging Voltage and Temperature

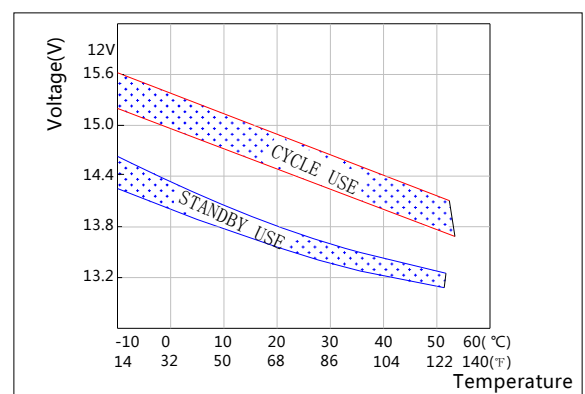

Floating Life on Temperature

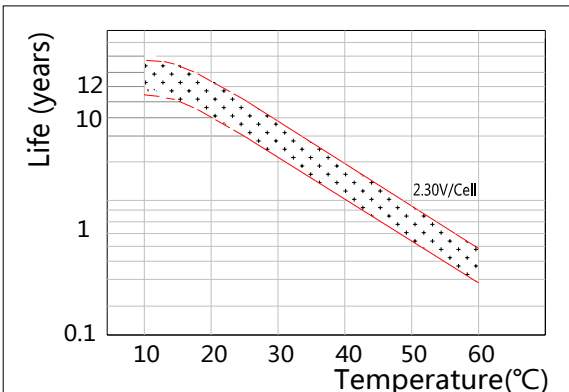

Cycle Life on D.O.D(25°C)

