

LFP12180D(12V180Ah)

Specifications

Nominal Voltage		12 V
Capacity (25°C)	10HR(10.8V)	180 Ah
	5HR(10.5V)	157.5Ah
	1HR(9.60V)	113Ah
Dimension	Length	494 ± 2mm (19.45inch)
	Width	206 ± 2mm (8.11inch)
	Height	209 ± 2mm (8.23inch)
	Total Height	T20: 235 ± 2mm (9.25inch) T11: 212 ± 2mm (8.35inch)
Approx. Weight		54kg (119.1lbs) ± 4%
Terminal type		T20/T11
Internal resistance (Fully charged, 25°C)		Approx. 3.3m Ω
Capacity affected by temperature (10HR)	40°C	102%
	25°C	100%
	0°C	85%
	-15°C	65%
Self-discharge (25°C)	3 month	Remaining Capacity: 91%
	6 month	Remaining Capacity: 82%
	12 month	Remaining Capacity: 65%
Nominal operating temperature		25°C ± 3°C (77°F ± 5°F)
Operating temperature range	Discharge	-15°C ~ 50°C (5°F ~ 122°F)
	Charge	-10°C ~ 50°C (14°F ~ 122°F)
	Storage	-20°C ~ 50°C (-4°F ~ 122°F)
Float charging voltage(25°C)		13.50 to 13.80V Temperature compensation: -18mV/°C
Cyclic charging voltage(25°C)		14.50 to 14.90V Temperature compensation: -30mV/°C
Maximum charging current		54A
Terminal material		T20: Lead, T11: Copper
Maximum discharge current		1400A(5 sec.)
Designed floating life(20°C)		7~10 years

- ◆ Absorbent glass mat technology;
- ◆ Recognized by UL & CE;
- ◆ ABS container.

Constant Current Discharge Characteristics (A, 25°C)

F.V/TIME	15min	30min	60min	2h	3h	4h	5h	6h	8h	10h	20h
9.60V	300	182	113	65.8	45.9	37.6	32.1	28.1	22.0	18.3	9.62
9.90V	293	178	111	65.4	45.6	37.4	31.9	27.9	21.9	18.3	9.60
10.2V	282	173	108	64.8	45.3	37.2	31.7	27.7	21.8	18.2	9.57
10.5V	272	169	106	63.8	45.0	36.9	31.5	27.5	21.6	18.1	9.52
10.8V	258	162	103	62.2	43.7	35.8	30.6	26.7	21.0	18.0	9.45

Constant Power Discharge Characteristics (Watt, 25°C)

F.V/TIME	15min	30min	60min	2h	3h	4h	5h	6h	8h	10h	20h
9.60V	3294	2040	1285	762	540	443	380	332	262	219	115
9.90V	3215	1999	1266	757	537	440	378	330	260	218	115
10.2V	3096	1938	1234	750	533	437	375	328	258	218	115
10.5V	2991	1891	1209	739	529	434	372	326	257	216	114
10.8V	2833	1822	1172	720	513	421	361	316	249	215	113

Note: The above characteristics data can be obtained within three charge/discharge cycles.

Dimensions

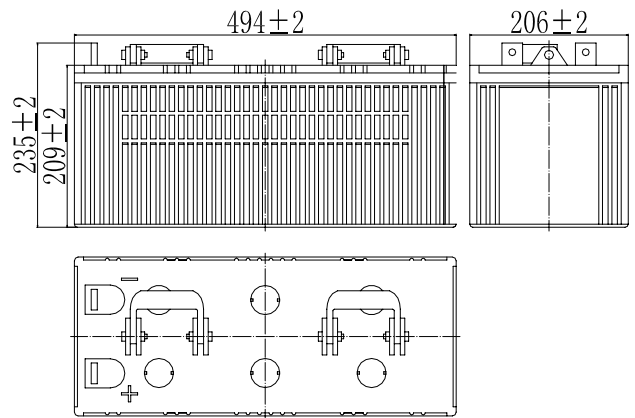

Terminal

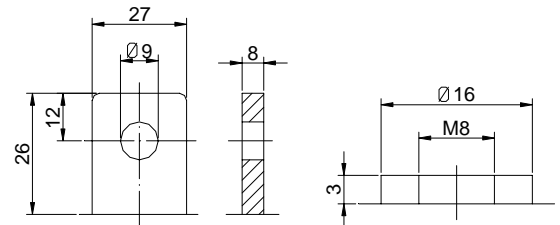

Terminal T20

Terminal T11

LFP12180D(12V180Ah)

Discharge Characteristics(25°C)

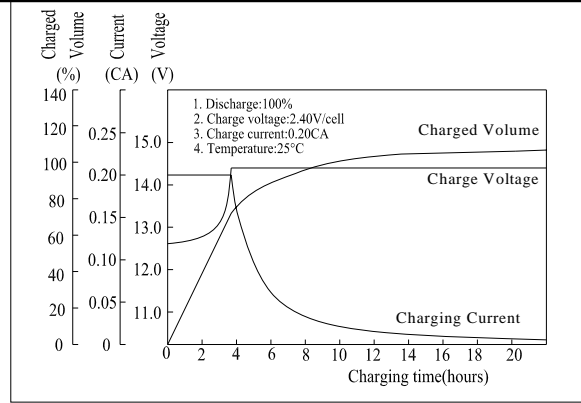
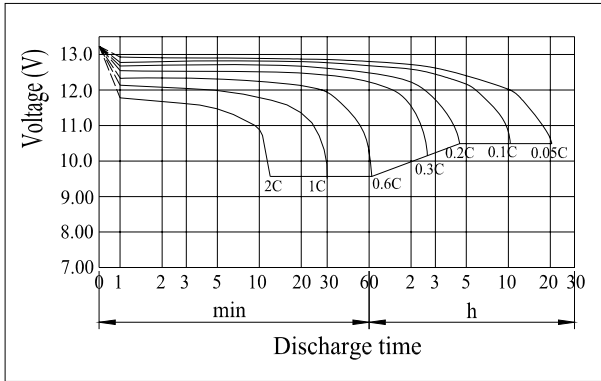

Effect of Temperature on Capacity

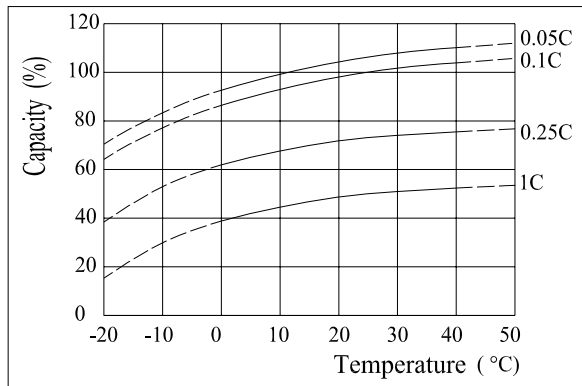

Self-discharge Characteristics

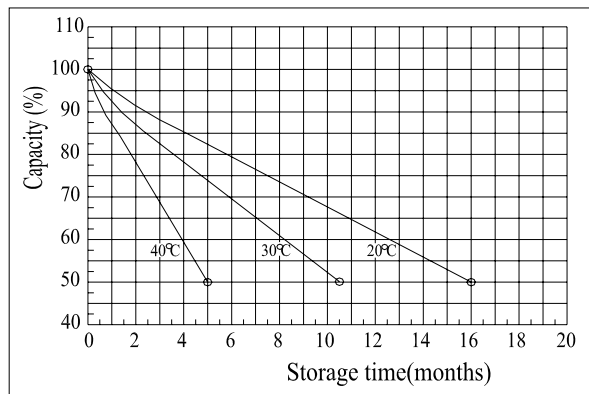

The Relationship for Open Circuit Voltage and Residual Capacity (25°C)

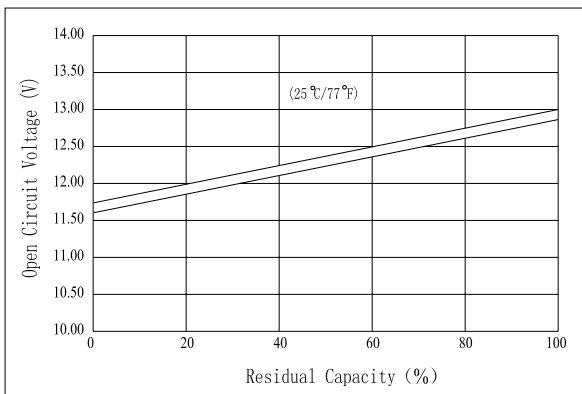

The Relationship for Charging Voltage and Temperature

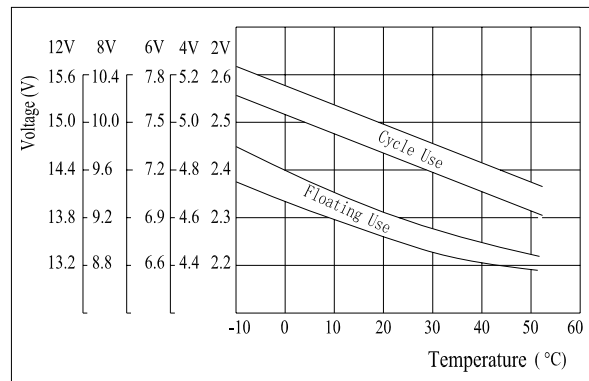

Floating Life on Temperature

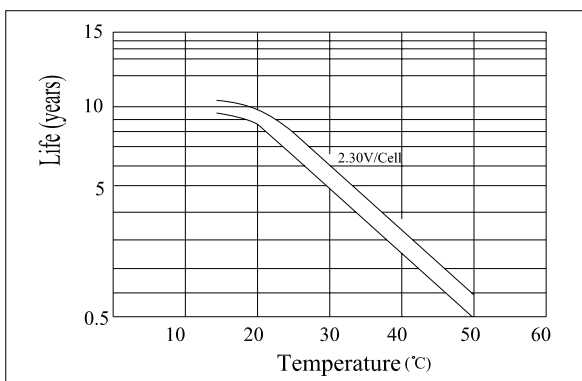

Cycle Life on D.O.D.(25°C)

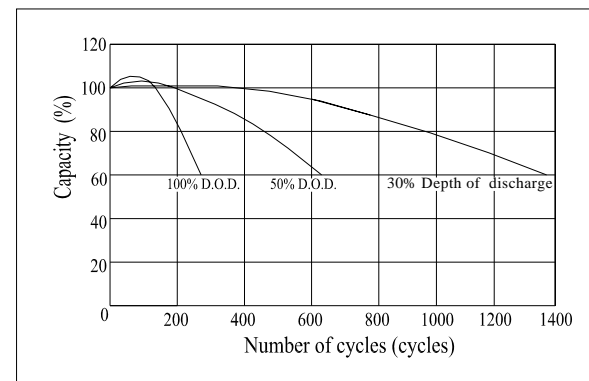

Charging Characteristics(25°C)