

LFP12150D(12V150Ah)

Specifications

Nominal Voltage		12 V
Capacity (25°C)	10HR(10.8V)	150 Ah
	5HR(10.5V)	130Ah
	1HR(9.60V)	93Ah
Dimension	Length	485 ± 2mm (19.09inch)
	Width	172 ± 2mm (6.77inch)
	Height	240 ± 2mm (9.45inch)
	Total Height	T5: 242 ± 2mm (9.53inch) T11: 240 ± 2mm (9.45inch)
Approx. Weight		44kg (97.0lbs) ± 4%
Terminal type		T5/T11
Internal resistance (Fully charged, 25°C)		Approx. 3.5m Ω
Capacity affected by temperature (10HR)	40°C	102%
	25°C	100%
	0°C	85%
	-15°C	65%
Self-discharge (25°C)	3 month	Remaining Capacity: 91%
	6 month	Remaining Capacity: 82%
	12 month	Remaining Capacity: 65%
Nominal operating temperature		25°C ± 3°C (77°F ± 5°F)
Operating temperature range	Discharge	-15°C ~ 50°C (5°F ~ 122°F)
	Charge	-10°C ~ 50°C (14°F ~ 122°F)
	Storage	-20°C ~ 50°C (-4°F ~ 122°F)
Float charging voltage(25°C)		13.50 to 13.80V Temperature compensation: -18mV/°C
Cyclic charging voltage(25°C)		14.50 to 14.90V Temperature compensation: -30mV/°C
Maximum charging current		45A
Terminal material		Copper
Maximum discharge current		1200A(5 sec.)
Designed floating life(20°C)		7~10 years

- ◆ Absorbent glass mat technology;
- ◆ Recognized by UL & CE;
- ◆ ABS container.

Constant Current Discharge Characteristics (A, 25°C)

F.V/TIME	15min	30min	60min	2h	3h	4h	5h	6h	8h	10h	20h
9.60V	250	152	93.9	54.8	38.3	31.4	26.8	23.4	18.4	15.3	8.02
9.90V	244	148	92.5	54.5	38.0	31.2	26.6	23.3	18.3	15.2	8.00
10.2V	235	144	90.2	54.0	37.8	31.0	26.4	23.1	18.1	15.2	7.98
10.5V	227	140	88.4	53.2	37.5	30.8	26.3	23.0	18.0	15.1	7.93
10.8V	215	135	85.7	51.8	36.4	29.8	25.5	22.3	17.5	15.0	7.88

Constant Power Discharge Characteristics (Watt, 25°C)

F.V/TIME	15min	30min	60min	2h	3h	4h	5h	6h	8h	10h	20h
9.60V	2745	1700	1071	635	450	369	316	277	218	182	96.2
9.90V	2679	1666	1055	631	447	367	315	275	217	182	96.0
10.2V	2580	1615	1028	625	444	364	312	273	215	181	95.7
10.5V	2492	1576	1008	616	441	362	310	271	214	180	95.2
10.8V	2360	1518	977	600	428	351	301	263	207	179	94.5

Note: The above characteristics data can be obtained within three charge/discharge cycles.

Dimensions

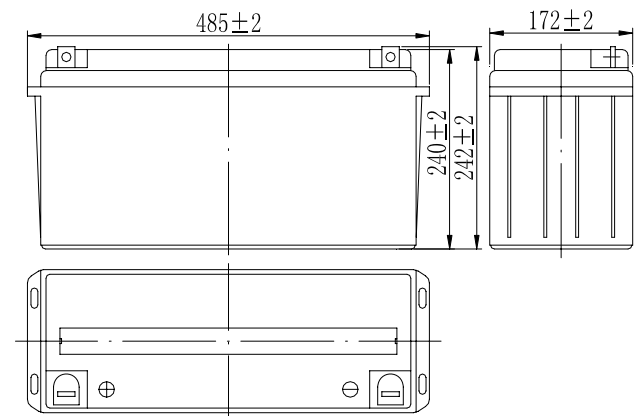

Terminal

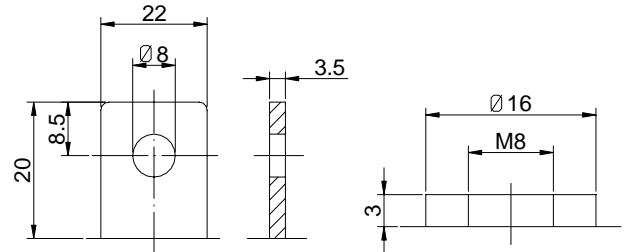

Terminal T5

Terminal T11

LFP12150D(12V150Ah)

Discharge Characteristics(25°C)

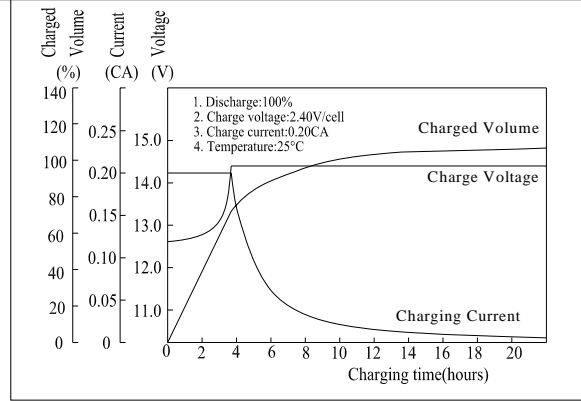
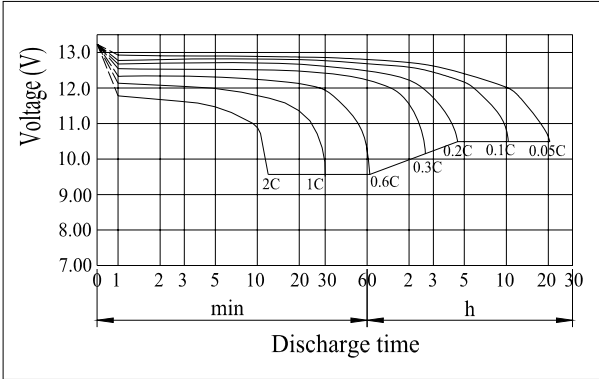

Effect of Temperature on Capacity

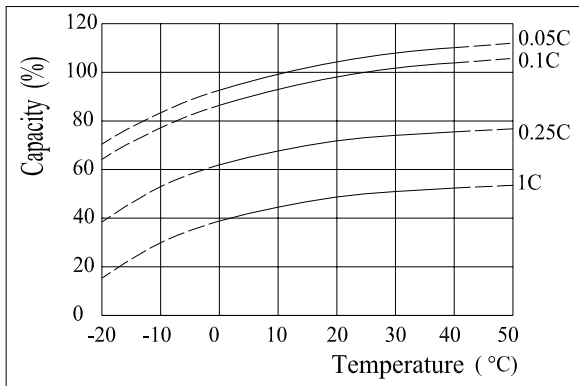

Self-discharge Characteristics

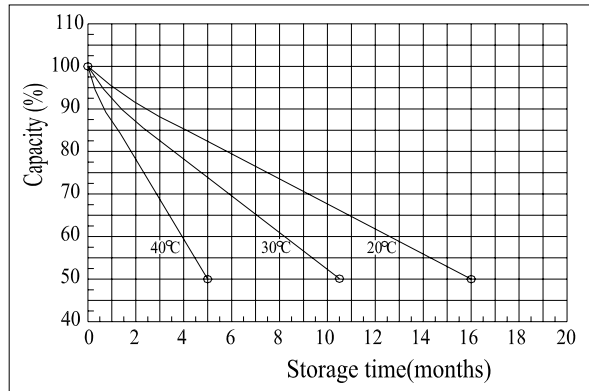

The Relationship for Open Circuit Voltage and Residual Capacity (25°C)

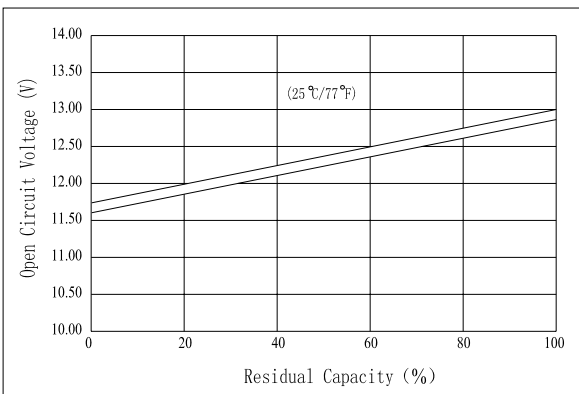

The Relationship for Charging Voltage and Temperature

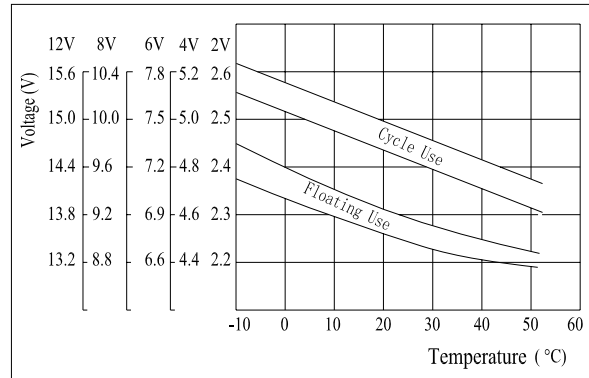

Floating Life on Temperature

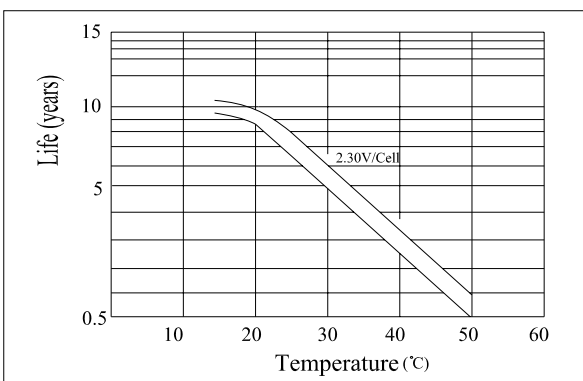

Cycle Life on D.O.D(25°C)

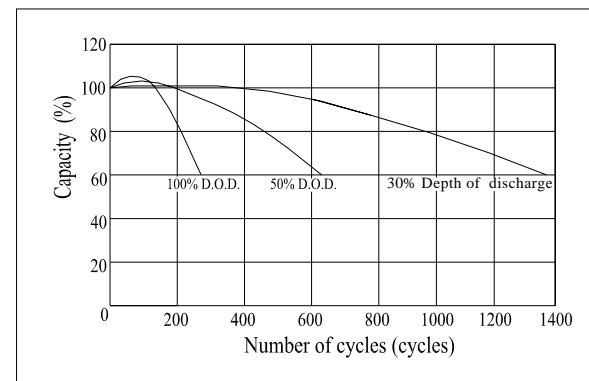

Charging Characteristics(25°C)